

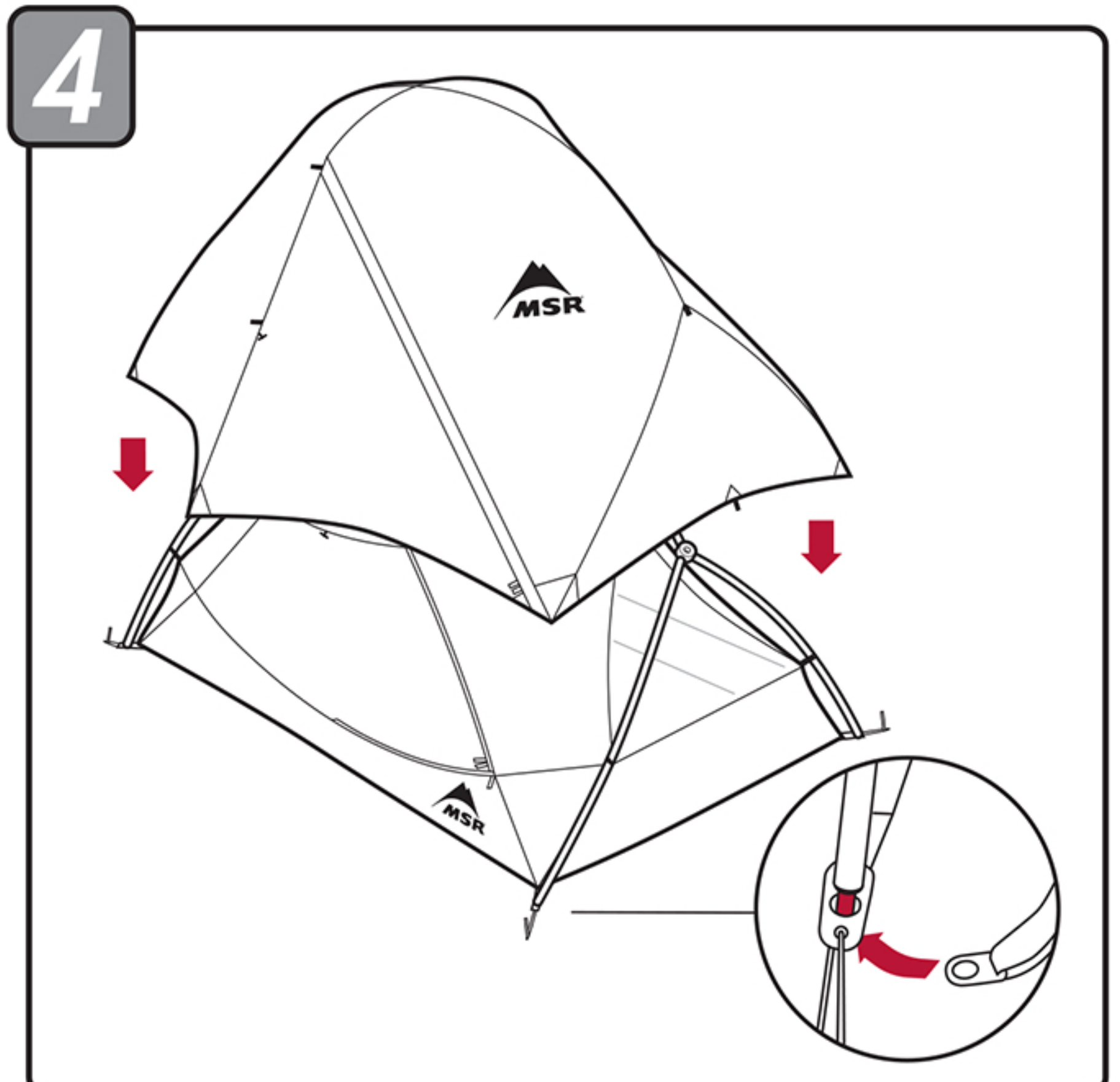

HUBBA HUBBA™ BIKEPACK 1

Assembly Instructions

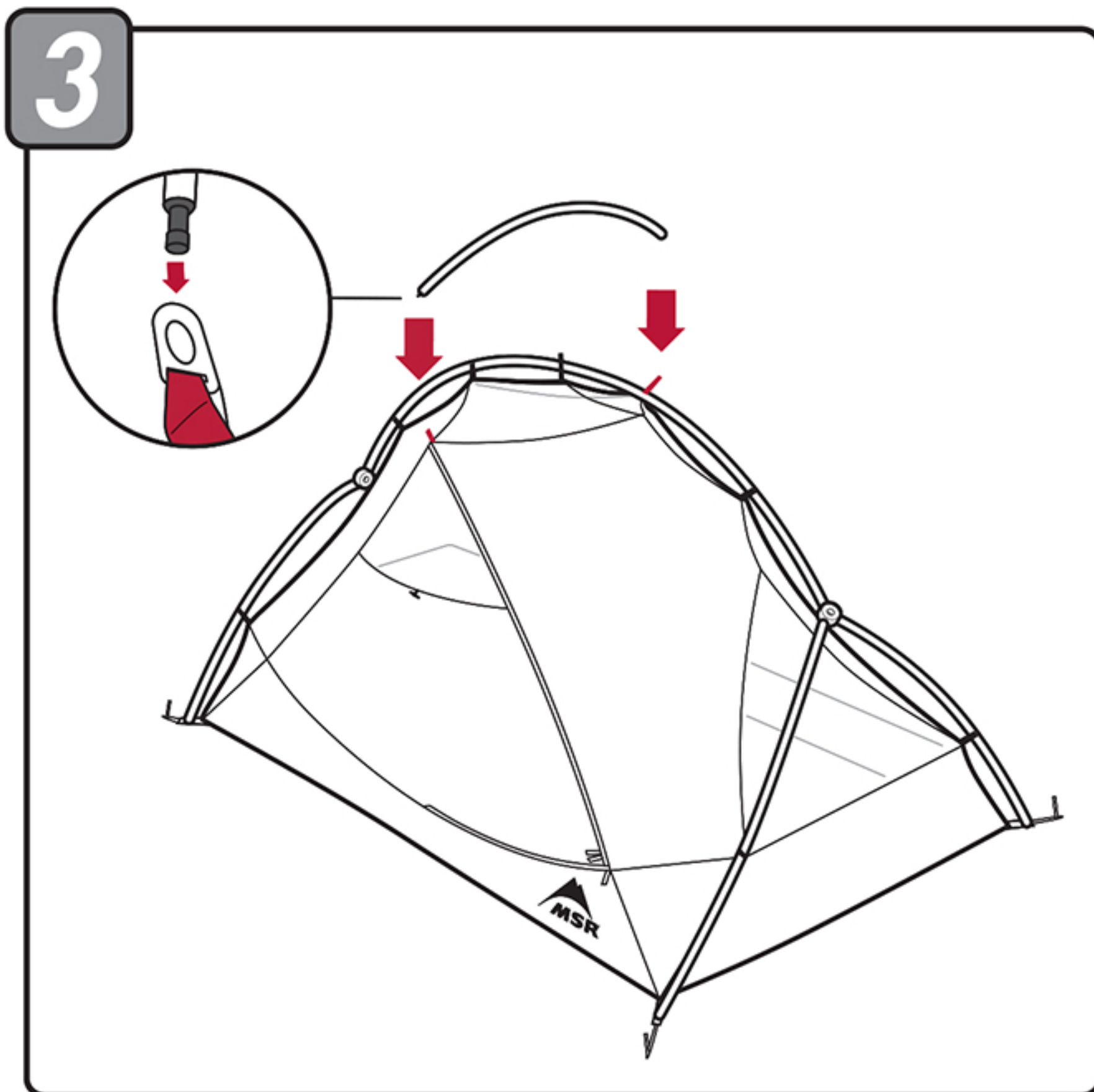
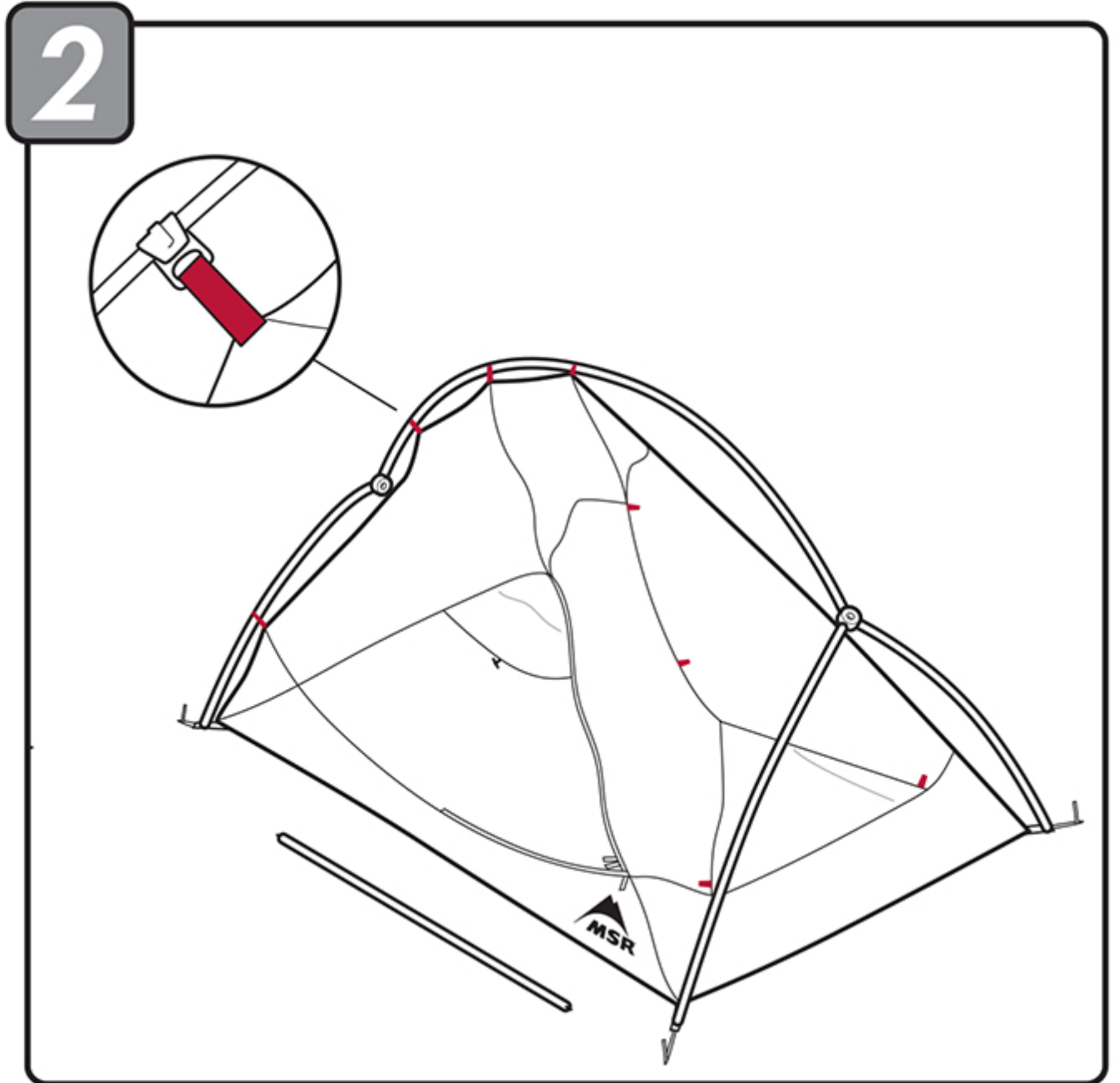
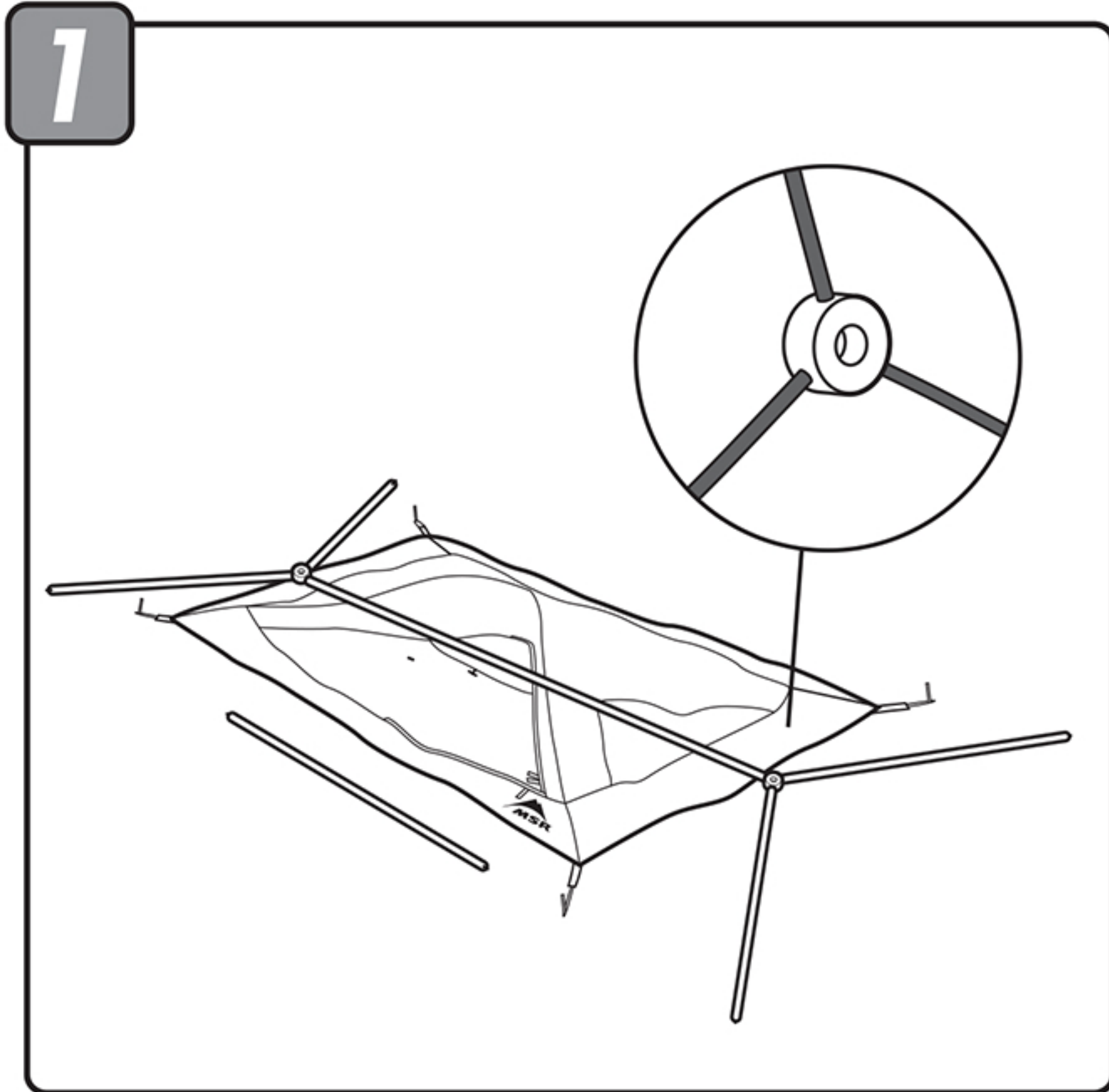

65% nylon / 25% polyurethane / 10% polyester



MOUNTAIN SAFETY RESEARCH®

© 2023 Cascade Designs, Inc.
4000 First Avenue South
Seattle, WA 98134 USA
1-800-531-9531 | 1-206-505-9500